

Trin & Stor

Model Numbers: ST Series
Version Date: 2017-09-25



STORAGE TANK INSTALLATION AND OPERATION INSTRUCTIONS Storage companion to a Water Heater or Solar Thermal System

TABLE OF CONTENTS

1.0	INTRODUCTION	2
	Trin & Stor Specifications	2
	General Installation Requirements	2
	I.O.M. Checklists.....	2
	Safe Temperatures for Potable Water	3
2.0	STORAGE TANK PIPING.....	5
	Storage Tank Piping	5
	Connection to a Water Heater.....	6
3.0	TANK SENSOR.....	8
4.0	START UP AND CHECK OUT	10
5.0	ANNUAL MAINTENANCE AND INSPECTION	10
6.0	PARTS LIST	10



HAZARD SYMBOLS AND DEFINITIONS



Danger Sign: Indicates a hazardous situation which, if not avoided, will result in serious injury or death.



Warning Sign: Indicates a hazardous situation which, if not avoided, could result in serious injury or death.



Caution Sign plus Safety Alert Symbol: Indicates a hazardous situation which, if not avoided, could result in minor or moderate injury.



Caution Sign without Safety Alert Symbol: Indicates a hazardous situation which, if not avoided, could result in property damage.

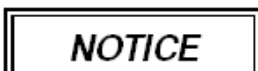

Notice Sign: Indicates a hazardous situation which, if not avoided, could result in property damage.



Tanks must be installed by a licensed installer. Improper installation, use, neglect or abuse of this product will void the warranty.

1.0 INTRODUCTION

Trin & Stor Specifications

Table 1-1 Storage Tank Specifications

Model	Storage Capacity (US Gal)	Type	Weight (lbs)	
			Empty	Filled
ST80	80	Stainless Steel Storage Tank	160	995
ST120	119		175	1275

The "ST" Series consists of a high performance stainless steel tank and can be used as a storage companion to a water heater or solar thermal system. For the complete NTI Trin & Stor line, visit www.ntiboilers.com.

Table 1-2 Storage Tank Characteristics

Attribute	ST Series	
Tank	stainless steel	
Insulation	EPS foam	
Jacket	grey plastic	
Recommended Service Clearances	top	12"
	connection side	12"
	water heater connections	as required
Restrictions	MAWP	150 psi
	Max tank temp	190°F
	Max water heater temp	210°F

NOTICE

Water Chemistry - Water used in the storage tank must meet the water chemistry limits specified in Table 2-1. Levels outside the limits may corrode the tank and shorten its life resulting to damage to tanks and voiding the warranty.

General Installation Requirements

Generalized instruction and procedures cannot anticipate all situations. For this reason, only a qualified installer should perform the installation.

Users Responsibility – This manufacturer anticipates the proper installation and care in use of the product. As with any hot water system, there is a risk of property damage and personal injury inherent in the use. NTI cannot supervise the installation and therefore makes it a specific condition for the warranty that the customer will supervise the installation and use of the product to be sure they are performed in accordance with the instructions and I.O.M. Checklists in this manual. It is the User’s responsibility to maintain the appliance by having it inspected on an annual basis, serviced as required, and to use the product for the purpose it was intended.

Installers Responsibility – A qualified installer is a licensed person who has appropriate training and a working knowledge of the applicable codes, regulations, tools, equipment and methods necessary to install a storage tank or water heater. The Installer assumes all responsibility for a safe installation and that it meets the requirements of this document, as well as National and local codes.

I.O.M. Checklists

The various Installation, Operation and Maintenance (IOM) Checklists contained in this manual are meant to be read in conjunction with the details, drawings and safety information to ensure a complete and proper installation.

General Information

1. Review system specifications and characteristics.
2. Know the Water Chemistry and Warranty requirements.
3. Be informed of potential hazards associated with potable water.

DOs & DON'Ts

1. DO NOT install tank close to high temperature appliances or wood stoves as tank jacket is combustible.
2. DO NOT install where there is a risk of property damage in the event of an eventual leak at some unpredictable time.
3. DO support the entire tank bottom with ¾" plywood (min) if elevating off the floor with blocks.

Pre-Installation Checklist **Inspection and Preparation**

1. Remove packaging. Inspect for damage during shipping.
2. Package contents should contain the following:

<input type="checkbox"/> Storage Tank (verify correct model number)	<input type="checkbox"/> Manual
<input type="checkbox"/> Temperature and Pressure Relief Valve (150psi)	<input type="checkbox"/> Warranty Card

Locating the Tank

1. Solid foundation, dry location, near water heater.
2. Leave room to service storage tank and controls.
3. Ensure there is sufficient room for piping and servicing the storage tank and water heater.
4. Area free of flammable liquids or combustible vapors.
5. Ensure the location chosen for the tank is capable of supporting the tank when filled with water.
6. Locate in room where temperature never drops below 50°F (10°C).

Water Damage Protection

1. Where possible, locate the storage tank in an area where potential leaks from the tank, fittings, connections, or relief valve will not result in water damage to adjacent areas or lower floors.
2. If the area surrounding the tank is susceptible to water damage, install a catch pan c/w drain under the tank.

NOTICE

Water Damage - This manufacturer is not responsible for any water damage that may occur in connection with the storage tank or any of its components.

CAUTION

Intended Purpose - This appliance is not intended to convey or dispense water for human consumption such as drinking or cooking.

WARNING

Annual Service - Failure to have the Storage Tank properly serviced and inspected on a regular basis by a qualified technician may result in property damage or serious injury.

Safe Temperatures for Potable Water

Two factors used to determine safe hot water temperatures are Legionella and scalding. Potable water needs to be stored at temperatures hot enough to limit the growth of Legionella, yet be cool enough to prevent scalding. Since both hazards present a potential risk to the user, they must be monitored and controlled. Table 1-4 indicates how water temperature affects Legionella bacteria and contributes to scald injury. Use of a thermostatic mixing valve in the storage tank plumbing system can help protect against both of these hazards. By storing potable water at higher temperatures, bacteria growth is controlled, while still providing high temperature water for dishwasher applications and low temperature water for bathing. Before proceeding, read the following carefully and take all necessary precautions to avoid potential illness and/or injury that can result from Legionella or scalding hazards.

WARNING

Legionella Hazard - This bacteria is naturally occurring in surface water and ponds. It can also be found in man-made water systems around the world such as water storage tanks, water distribution systems, fountains, hot tubs, humidification systems, refrigeration systems and grocery produce misters. Health authorities agree that Legionella bacteria most often enter the lungs due to aspiration when contaminated water spray is breathed in as opposed to ingesting drinking water contaminated with the bacteria. Typical illnesses attributed to Legionella include flue like symptoms (Pontiac Fever) and a potentially fatal type of pneumonia (Legionnaires' disease). Failure to follow instructions may result in illness or death.

Contributing Factors to Legionella - Experts acknowledge that Legionella is an identified risk in most water systems. Although eradicating Legionella is improbable, precautions can be taken to control and monitor conditions that promote bacteria growth. According to the World Health Organization (WHO); American Society of Heating, Refrigeration, and Air-conditioning Engineers (ASHRAE); Canada Safety Council (CSC); and Centers for Disease Control (CDC), contributing factors to the growth of Legionella in potable water systems include:

- Minerals and nutrients present in the source water and systems materials
- Stagnation or low flow characteristic of dead ends in distribution piping systems and storage tanks
- Scale, corrosion, and bio film
- Tepid water in cold water lines
- Water storage temperatures optimal for bacteria growth
- Chlorine concentration

**WARNING**

Scald Hazard - Hotter water increases the risk of scald injury. There is a hot water scald potential if the storage tank thermostat is set too high. Before changing the temperature setting on the tank thermostat, refer to the thermostat manufacturers recommended settings. Failure to follow these instructions may result in serious injury or death.

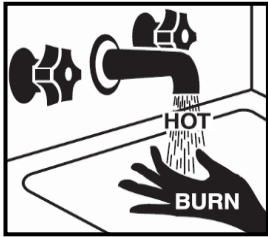

A scald injury can occur when hot steam or liquid makes contact with one or more layers of skin. Scald severity (degree of burn) is directly impacted by exposure time and temperature. Refer to Table 1-4. The following basic precautions are common sense:

- Young children and elderly adults burn more quickly and should use cooler water.
- Never leave a child alone while drawing water in a bathtub.
- Test the water temperature before bathing or showering.
- Turn cold water on first, then add hot water until the temperature is comfortable.

**WARNING**

Thermostatic Mixing Valve - When the system requires water at temperatures higher than required for other uses, such as high temperature applications typically greater than 46°C (115°F), a means such as a thermostatic mixing valve shall be installed to temper the water for those uses in order to reduce scald hazard potential. Anti-scald devices such as a thermostatic mixing valve allows potable water to be stored at a higher temperature to limit bacteria growth, and allows water at the tap to be delivered at a lower temperature to prevent scalds. Failure to follow these instructions may result in serious injury or death.

**CAUTION**

This appliance is not intended to convey or dispense water for human consumption such as drinking or cooking.

**IMPORTANT**

Legislation and Guidelines - At the time this document was written, standards and guidelines regulating the prevention of Legionella in the United States and Canada were mostly voluntary. The American Society of Heating, Refrigerating and Air-Conditioning Engineers, Inc. (ASHRAE) is currently in the process of converting its guideline entitled "Minimizing the Risk of Legionellosis Associated with Building Water Systems" (ASHRAE Guideline 12-2000) into an official standard. Consult with your local authorities as to recommended guidelines for controlling Legionella in potable water systems.

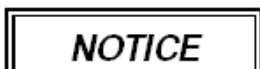
**NOTICE**

Storing water at temperatures $\geq 140^{\circ}\text{F}$ may not be permitted in some States, so check with the authorities having jurisdictions. In Canada, recent changes to the National Plumbing Code requires that domestic hot water be stored at or above 61°C (140°F) and then mixed down to safe temperatures at the tank outlet.

General Guidelines - In the absence of a National standard or local codes, the following are general guidelines for "good practice" on maintaining, monitoring and operating your potable water system:

- Store domestic hot water at temperatures $\geq 61^{\circ}\text{C}$ (140°F).
- Store and distribute cold water at temperatures below 20°C (68°F).
- System supply for uses other than high temperature applications typically greater than 46°C (115°F) shall be equipped with a thermostatic mixing valve on the hot water outlet to reduce potential scald hazards.
- Clean aerators and nozzles on water fixtures on a regular basis to reduce scale build-up.
- Clean storage tanks and remove sediment. Flush storage tanks and piping systems regularly for 10-30 minutes at high water temperatures (depending on guidelines used) to rid the system of sediment and scale that develops, typically in the bottom of storage tanks where water temperature is coolest; and piping runs where water can stagnate.
- Abandoned water lines should be capped off at the distribution main, not at the most convenient place.

- Avoid dead-ends in piping system. If unavoidable, provide a drainage port in these areas at the lowest point to flush out stagnant water regularly.
- Insulate Domestic Hot Water recirculation lines and keep pipe runs as short as possible.
- Recommend annual water testing of water in your tank and piping system(s) to monitor water conditions.
- Keep a maintenance record of when your water heater and storage tank were cleaned, piping systems flushed and who did the service work.

Table 1-4 How Water Temperature relates to Legionella and Scald Hazard

Water Temperature ¹		Legionella Bacteria ¹	Water Temperature ^{2,5}		Exposure Time vs Burn ⁵
158-176°F	70-80°C	Disinfection range	158°F	70°C	1 second - 2 nd or 3 rd degree burn
140-149°F	60-65°C	Bacteria die within minutes	140°F	60°C	5 seconds - 2 nd or 3 rd degree burn
122-131°F	50-55°C	Bacteria die within hours	131°F	55°C	5 seconds - 1 st degree burn
68-113°F	20-45°C	Bacteria thrive and multiply	122°F	50°C	1 minute - 1 st degree burn
below 68°F	below 20°C	Bacteria is dormant	111°F	44°C	5 hours - 1 st degree burn ^{3,4}

Notes:
¹ Published by Chartered Institute of Plumbing and Heating Engineering, Databyte series, "Safe Hot Water Temperatures".
² The elderly and small children are susceptible to bad burns at shorter exposure times than listed in this table.
³ A thermostatic mixing valve should be installed on DHW storage tanks when outlet temperatures exceed 115°F [46°C].
⁴ Typical water temperature for bathing or showering range between 98-113°F [37-45°C].
⁵ Temperature-Time-Burn Chart published by John Hopkins University, excluding notes.

2.0 STORAGE TANK PIPING



Failure to follow the instructions provided in this section will void your NTI warranty and may result in property damage.

Storage Tank Piping

Tank connection ports are identified in Figure 2-1 and dimensioned in Tables 2-3 and 2-4 and their function is described in detail below. For multiple storage tanks, pipe the tanks in parallel using equal pipe lengths between each tank and a common tee to ensure equalized draw.

Energy Efficiency - Although the NTI Trin & Store Storage Tank is well insulated, insulating long pipe runs can improve the system efficiency by conserving energy and reducing standby losses.

System Preparation - Prior to connecting plumbing to the storage tank, flush the entire system to ensure it is free of harmful impurities. Check the water composition of the domestic water supply to determine if it is within the water chemistry limits specified in Table 2-1. If levels are outside the acceptable limits, consult a qualified water treatment expert about treatment options for domestic water.



Damage to tanks resulting from water chemistry levels outside the ranges specified in Table 2-1 can cause corrosion, shorten the life of the tank, and void the warranty.

Table 2-1 Water Chemistry Requirements

Characteristic	"ST" series	
PH	Min	6.0
	Max	8.0
Chloride (ppm)	Min	0.0
	Max	80.0



Flushing the Storage Tank - Many solder fluxes can severely corrode stainless steel. Once piping connections are completed, flush the storage tank by drawing at least three (3) times the tank's volume through the storage tank prior to heating domestic water in the tank. Failure to flush the tank will void the warranty.

System Components - As a minimum, a properly installed system will include the following major components identified in Table 2-2. It is the responsibility of the installing contractor and system designer to consider all aspects of a proper system design including compliance with local codes, including additional components required for prevention of thermal-siphoning (i.e. heat traps), isolation valves, drain and purge valves, etc.

Table 2-2 Major Component Checklist

Factory Supplied Components	Field Supplied Components
<input type="checkbox"/> Storage Tank	<input type="checkbox"/> System Backflow Preventor ¹
<input type="checkbox"/> Temp & Pressure Relief Valve (150PSI)	<input type="checkbox"/> DHW (Potable Water) Expansion Tank ^{1,2}
	<input type="checkbox"/> Thermostatic (Anti-Scald) Mixing Valve
	<input type="checkbox"/> Drain Valve
	<input type="checkbox"/> Potable Water Circulator (as required)
	<input type="checkbox"/> Control Thermostat

Notes:

¹ Check if required by local codes.

² Expansion Tank is mandatory if using a System Backflow Preventer.

Temperature and Pressure Relief Valve - Factory supplied T&P relief valve, sized to ASME specifications and compliant with Standard ANSI Z21.22•CSA 4.4 Relief Valves for Hot Water Supply Systems.



T&P Normal Operation - The relief valve is not intended for constant duty such as repeated operation due to normal system expansion. If this occurs, correct the situation by installing a properly sized domestic expansion tank as per the expansion tanks manufacturer’s instructions.



Location - Do not conceal, plug, or remove the relief valve from its designated point of installation. Failure to comply may result in property damage, personal injury or death.

Drain Valve - The Storage tank requires a field supplied drain valve to facilitate emptying the tank for inspection and servicing. Refer to Table 2-4 for drain port size and type.

System Backflow Preventor - Most plumbing codes require a thermal expansion control device be installed if a backflow preventor, pressure reducing valve or check valve is installed on a domestic supply line. If a backflow prevention device is used, then an expansion tank is mandatory (not optional) and must be installed downstream of any device used to control system thermal expansion. When using multiple storage tanks, check if a single BFP is required on the domestic supply or if each tank requires it’s own backflow preventor and expansion tank.

DHW (Potable Water) Expansion Tank - This manufacturer recommends installing a potable water expansion tank in the hot water system for the purpose of absorbing the increase in water volume caused by rising water temperature. If required by local codes, the expansion tank must be sized in accordance with the water volume of the system. Refer to the expansion tank manufacturer’s literature for proper sizing information.

Thermostatic (Anti-Scald) Mixing Valve - A mixing valve is recommended on branches supplying low temperature water to endpoint plumbing fixtures when domestic hot water is stored above 46°C (115°F).



Temperature Limiting Device - When the tank requires water at temperatures higher than 46°C (115°F), a mixing valve shall be installed to temper the water and reduce the risk of scalding. Failure to follow these instructions may result in serious injury or death.

Connection to a Water Heater

The NTI Trin & Stor Storage Tanks are intended to be heated by an external hot water heater or solar thermal system and supplied directly to the storage tank using connection ports 4 and 5. See Figure 2-1.



High Temperature Applications - Trin & Stor Storage Tanks are specifically designed for low temperature applications [$<100^{\circ}\text{C}$ (210°F)] and are NOT intended to be used as a pool heating system or in conjunction with high temperature steam producing appliances where water temperatures could potentially exceed 100°C (210°F). Failure to follow these instructions may damage the tank resulting in property damage, serious injury or death.

Figure 2-1 Storage Tank Dimensions

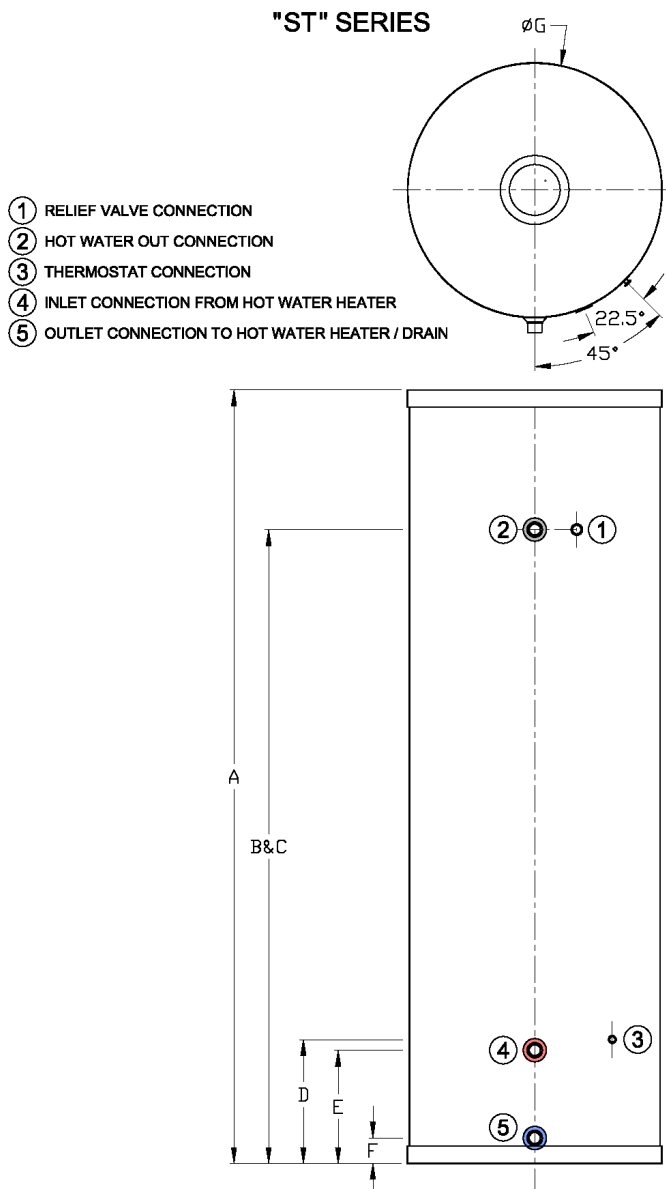

Installation Checklist

1. Install piping as per National and local codes.
2. Mark the water supply for future reference.
3. Install a thermostatic mixing valve on the hot water outlet of the storage tank.
4. Install hot water heater plumbing connections as per the water heater manufacturer's instructions.
5. Install T&P relief valve on tank in accordance with local codes.
6. Ensure any valves installed between the expansion tank and storage tank inlet are left in the OPEN position during normal operation.
7. Ensure no valve is installed between the relief valve and discharge pipe.
8. Ensure discharge piping material used is rated to withstand temperatures up to 250°F (120°C).
9. Direct discharge to a safe area (drain) where hot water or steam will not cause damage or injury.
10. Terminate discharge pipe 6"-12" above the floor. Do not connect discharge pipe directly to a drain.
11. Typical discharge pipe diameter ¾". Maximum pipe length is 15 feet with 2 or less elbows.
12. Cut discharge end of pipe at a 45° angle to reduce the risk of being blocked or capped.
13. Verify with local codes if a backflow preventor or thermal expansion control device is required.
14. Install a domestic expansion tank downstream of the backflow preventor (control device).
15. Install the domestic expansion tank on the cold water supply.
16. Flush the tank thoroughly before filling the tank in preparation to heat water.

Table 2-3 Storage Tank Dimensions

Model	Dimensions (inches)						
	A	B	C	D	E	F	G
ST80	72 5/8	59 1/2	59 1/2	11 5/8	10 5/8	2 3/8	23 7/8
ST120	64 3/4	52 3/8	52 3/8	13 1/4	12 1/4	2 3/8	28 7/8

Table 2-4 Storage Tank Connections

Model	Connection Port Sizes				
	T&P RV	Hot Out	Sensor	HWH In	HWH Out
	1	2	3	4	5
ST80	1" F	1 1/2" M	Well	1 1/2" M	1 1/2" M
ST120	1" F	1 1/2" M	Well	1 1/2" M	1 1/2" M

General Notes:

- Connections are NPT unless noted otherwise.
- The sensor connection is a friction fit immersion well.

Filling the Storage Tank

1. Thoroughly flush the storage tank by drawing three (3) times the tank's volume through it.
2. Verify water connections completed.
3. Close drain valve. Open the highest hot water faucet.
4. Open valve on cold water inlet and fill system.
5. Fill until a steady stream of water flows from the hot water faucet.
6. Close the hot water faucet.
7. Ensure the storage tank is filled and piping is free of leaks before proceeding to Operational Checklist in Section 4.0.



3.0 TANK SENSOR

NTI offers an optional Tank Sensor (p/n 84632), which is compatible with all NTI-Trinity Lx series water heaters; follow the instructions below for proper installation, wiring and water heater control setting adjustments.

NOTICE

The Tank Sensor is NOT compatible with NTI-Trinity Lx series water heaters that are wired together as part of a multiple water heater cascade (i.e., when they are “Lead-Lagged” together). When using a Trin & Stor Storage tank with a cascade water heater system, the TPI Control Thermostat, other thermostat or aquastat must be used. Installation instructions are included with the TPI Control Thermostat.

Installation Instructions

1 LOCATE THERMAL WELL

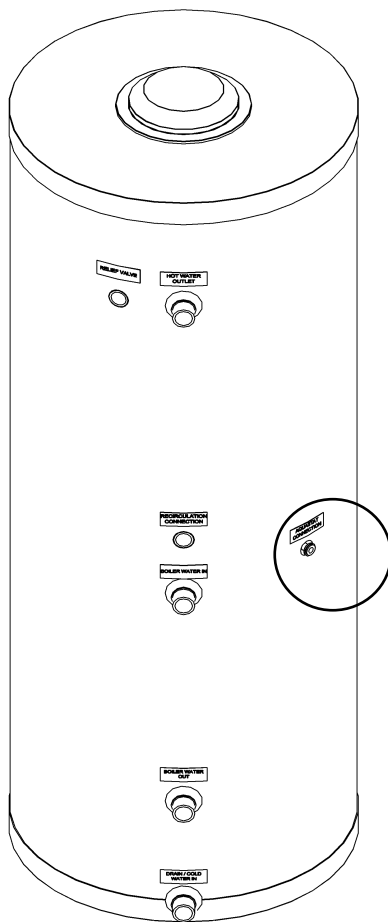

2 INSERT TANK SENSOR

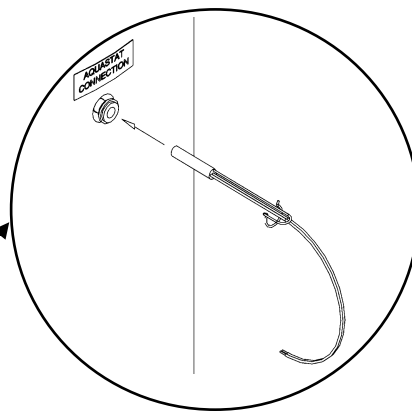

3 SECURE TANK SENSOR

Hook wire retainer to the back of the Thermal-Well rib; pull to ensure it will not fall-out.

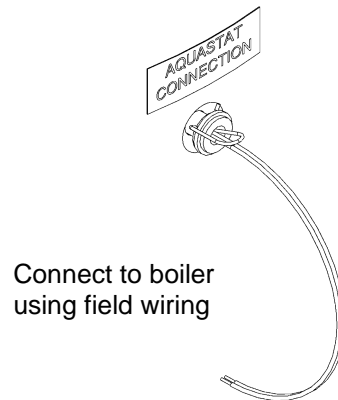

4 WIRE TANK SENSOR TO WATER HEATER

Figure 3-1 Tank Sensor to Trinity Lx Water Heater

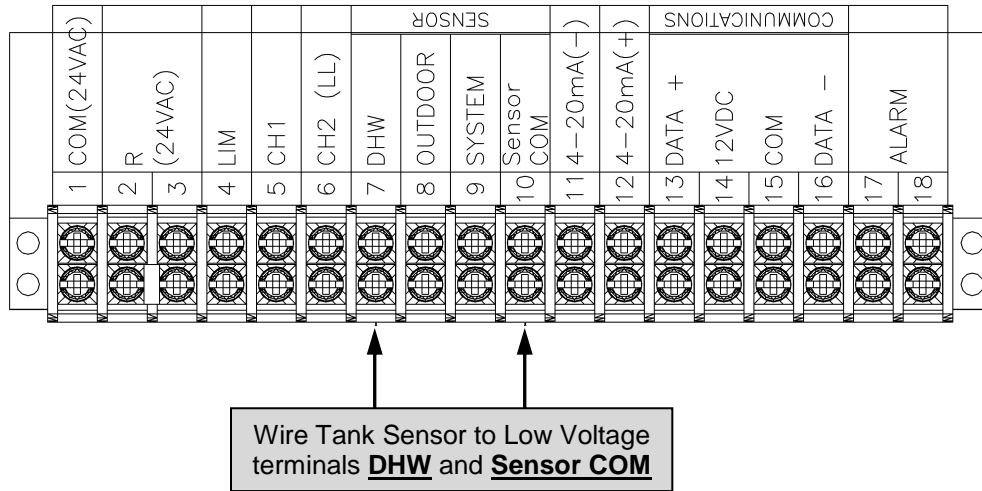

5 ADJUST TRINITY LX WATER HEATER CONTROL SETTINGS

In order for the Water Heater to operate correctly with the Tank Sensor, some control settings need to be adjusted. Navigate to the Domestic Hot Water Configuration screen and make the following adjustments to the settings; see Figure 3-2 (note: you must login before adjustments can be made):

1. **Demand switch** – change setting to “DHW sensor with On/Off temperatures”
2. **Modulation sensor** – maintain factory setting of “Outlet sensor”
3. **Setpoint** – set to the desired Water Heater operating temperature during a DHW demand; should be set higher than the “Demand Off temperature”. Typical setting = 130°F to 190°F.
4. **Demand On temperature** – tank temperature where a DHW demand is initiated, must be set lower than the “Demand Off temperature. Typical setting = 120°F to 175°F.
5. **Demand Off temperature** – tank temperature where a DHW demand is ended, must be set higher than the “Demand On temperature. Typical setting = 125°F to 180°F.

Figure 3-2 Trinity Tft & Lx Series Control Adjustments

For more information on adjusting the Water Heater control settings, refer to: APPENDIX A of the Trinity Lx Water Heater Instruction Manual.

4.0 START UP AND CHECK OUT

Operational Checklist

1. Ensure all electrical connections are made correctly and no high voltage wires are exposed.
2. Ensure the Tank Sensor is correctly installed, and the Trinity Lx Water Heater is correctly reading the tank temperature. In lieu of the Tank Sensor ensure the Thermostat demand is properly signaling the boiler to operate.
3. Set the Water Heater to the desired temperature.
4. Ensure piping system is free of leaks and that air has been purged from system.
5. Initiate a call for hot water by opening hot water taps on domestic water fixtures.
6. Verify that the water heater and recirculation pump starts when the tank temperature drops below the “Demand On temperature” and shuts down when the tank temperature rises above the “Demand Off temperature”. See Figure 3-2.
7. Check for proper operation of relief valve by opening it manually.
8. If relief valve functions continuously during normal operation, the expansion tank may need to be upsized.

5.0 ANNUAL MAINTENANCE AND INSPECTION

Inspection Checklist

1. Perform a visual inspection of all valves, drains, and system piping for signs of leaks.

Maintenance Checklist

1. Verify maximum water temperature at hot water fixtures to verify mixing valve temperature settings.
2. Manually operate T&P relief valve by moving lever to open position until hot water is released and allow it to snap close. If closed relief valve continues to leak, close cold water inlet, drain tank, and replace relief valve.
3. If relief valve functions continuously during normal operation, the expansion tank may need to be upsized.
4. Ensure the water heater and/or solar thermal system is maintained in accordance with its installation manuals.
5. Check function of field-installed controls, thermostats, and circulators.
6. Check tank PH and chloride levels to determine if water chemistry is within the specified range.
7. Any additional procedures required by local codes.

Draining the Storage Tank

1. Disconnect the power supply to the heat source.
2. Purge hot water from the tank by opening a hot water faucet.
3. Close the cold water supply shut off valve.
4. Open the drain valve and divert water in tank to alternate storage location or floor drain.
5. Open highest hot water faucet to allow air to enter the system.

6.0 PARTS LIST

Table 6-1 Storage tank

Item	Part #	Models	Description
1	84156	ST80, ST120	Relief Valve, T&P, ¾", 150 psi
2	84632	ST80, ST120	Tank Sensor
3	84158	ST80, ST120	TPI Control Thermostat



Installers requiring technical assistance can contact NTI directly at 1-800-688-2575.



NY Thermal Inc. 30 Stonegate Drive Saint John, NB E2H 0A4 Canada
Technical Assistance: 1-800-688-2575
Website: www.ntiboilers.com
Fax: 1-506-432-1135